

; <? ; : J



▶ /, Ž''DNž :J ;<? ----- +)

▶ ;:J Q :/' ;<? &lt;? Q GJ+' ----- +,

▶ Q :/' \* ----- +.

▶ /- )''DN ;:J ----- ,(

▶ -''DN ;<? ----- ,+

▶ ----- ,.

▶ 8>: ----- -)

▶ \*''DN ----- -.

▶ Q :/' \*/ D:J ----- .'

▶ ;<? ----- ,.

▶ ----- .0

▶ /( /) !\*, 'DN ----- /,

▶ ----- /0

O; : /' ' &E \kGS:

; : J



O; : /' ' &E \kGS: \*' ' DN &' ' DN  
O; : /' ' &E \kGS: @E=@' &JPD G? F E P N ; G=S@@F MBK@ E  
K<C<G<I D SOG @8 KGJ : <E KLD SOC& J\*' ' ' KF JD 8GS, J  
D 8I B\$M D 8O; E 8  
O; : /' ' &E \kGS:

; : J )' ' 0'

(\*' ' DN  
( ' ) , '  
( , '

; : J 8GJ  
=JJJ&9DJ J: J D: J ; 8J <: J ; <? D<?  
<KJ 9G: 9FG\$ : J  
J@

\*''DN & ''DN  
\*, 'DN &-'DN &('''DN Ž ž  
\*''DN &,'DN \*''DN

)''O O; : /''

)' (, \$)' ( O; : /''

E\kG8:

O; : /'' &E\kG8:

(%`

O; : /'' &E\kG8:

O; : /'' &E\kG8:

(%`

O; : /'' &E\kG8:

@FO' '(

O; : /'' &E\kG8:

(%`

O; : /'' &E\kG8:

O; : /'' &E\kG8:

O; : /'' &E\kG8:

O; : /'' &E\kG8:

O; : /'' &E\kG8:

O; : /'' &E\kG8:

(%`

)%

O; : /'' &E\kG8:

G8:

O; : /'' &E\kG8:

@E=@' &JPD G? FEP

N; G=\$@F MBK@E

K<C<G<I D SOG

@B KGJ

: <E KLD SOC& J\*''

KFJD 8G\$ J

D 8I BSM

D 8O; E 8

(ž

)ž

\*ž

+ž

,ž

-ž ; : J ; <? D<? <KJ

9G:

9FG ; : J

.ž ; : J

(ž

O; : /'' &E\kG8:

)ž

O; : /'' &E\kG8:

; : J

)

O: /' ' &E \K8:



9FGS : J

; : J

GC

O: : / ' ' &E \ K8:

: : J



/) - ' ' DN ; : J

... · O; : / ' ' /) 899 ' @ = @'

· O; : / ' ' @ = @' N; G = \$ @ @ - ' ' DN ; : J ; < ?







)  
 ( (' M : ) + M :  
 (' ' D Ygj O : :  
 O : L  
 (' D Ygj O : : / ' ' O : L  
 O : L ) + M :  
 O : : @F  
 HEO

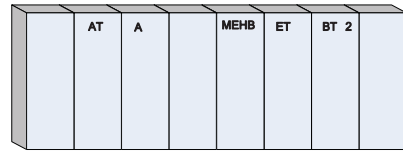
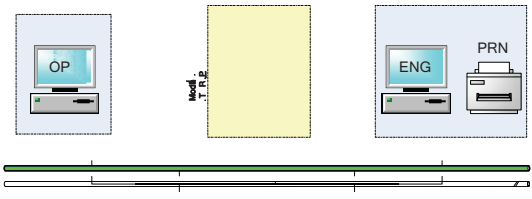

(  
 ( FGL (  
 Ž&E>ž ; : J  
 ; : J  
 ( FGL ( Ž&E>ž ( Ž KN ž  
 <?  
 \* \* (  
 <K; (& <KJM  
 <?

oJ; KJ@  
 9I 8LE  
 GI @ <D I

(\*fl F G:  
 GCL @/B F G:

CM K

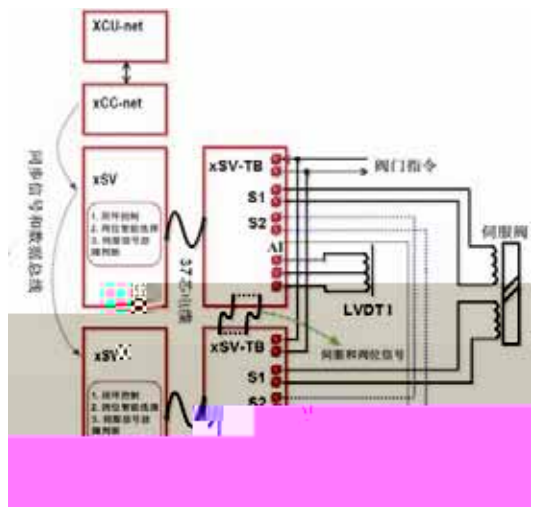

) oJM

(ž  
 ) ž  
 (š)  
 , dj  
 \*ž  
 +ž  
 CM  
 , ž

oCG  
 <KJ

+%

><

><

><

; <?

><



+

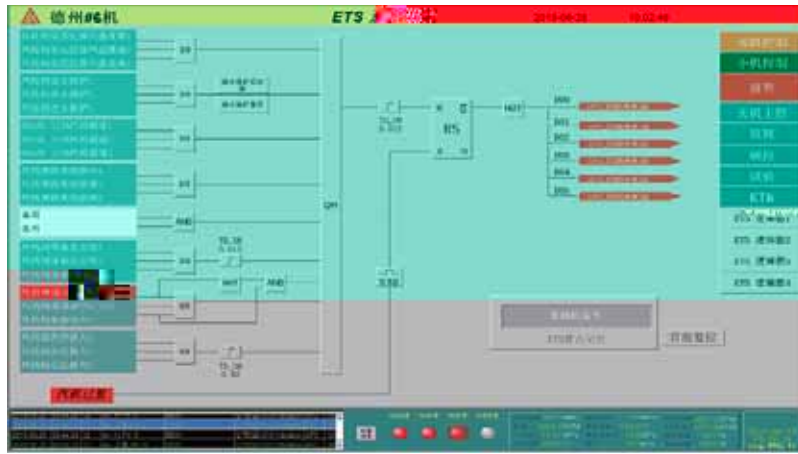

, <KJ



, %

— / —  
)' ( ,

)' (- , /  
, / - /  
- ' ' DN

- ' ' DN & ' ' DN )

⊕

;- \*''DN  
; : J ; <? D<?

... O:/' /- ;:J  
;:J  
'O:/' \*''DN

\*''DN  
; : J  
: <E KLD SOC =JJJ  
@E =@S0' : ? : ? OSSS

/- \*''DN ;:J ; <? D<?

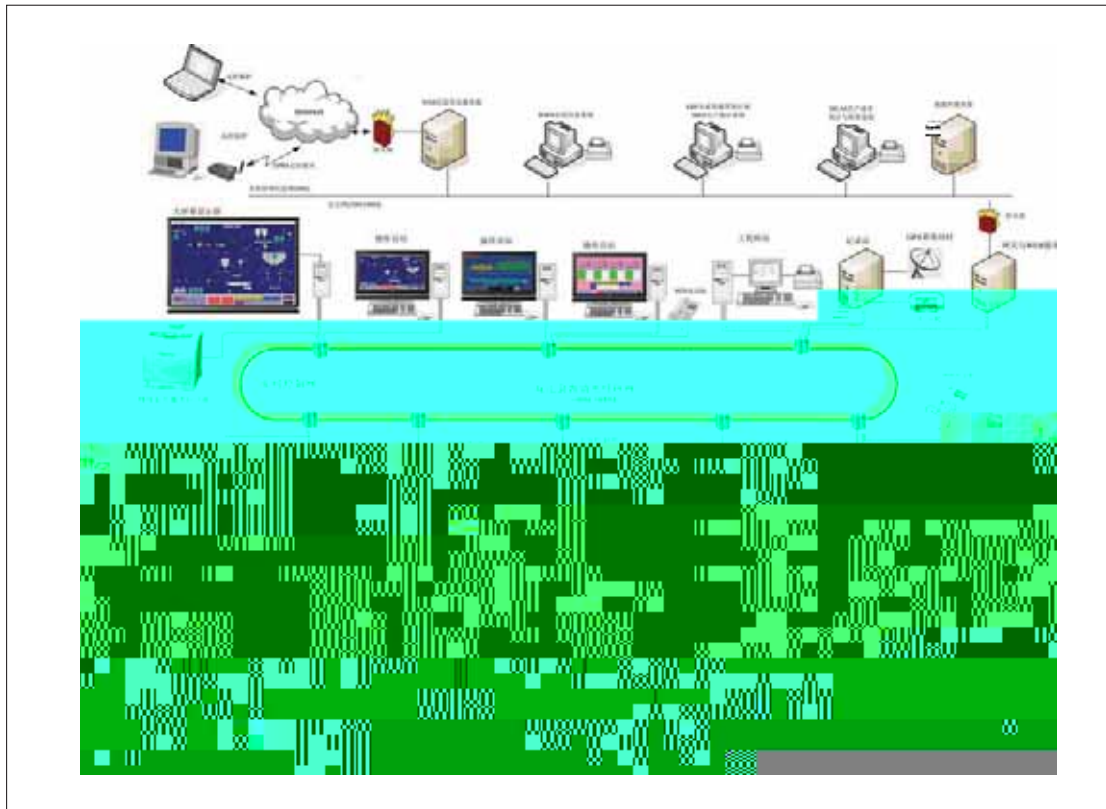

/ - \* ' ' D N : : J : <? D <?

( ' Q : / ' ' )

:  
 ? D @  
 \* ž  
 + ' ' ; <? & D <? )'  
 < KJ GC : : J  
 : : J  
 + ž  
 @ : 9 S + < & I & P  
 , ž  
 GJ - 0 ' L D f [ 9 l j  
 : : J : : J  
 : : J  
 - ž  
 O : : / ' ' )  
 < KJ GC : : J

; <? & D <? & KJ  
 : : J  
 D : J J : J  
 ; 8 J = J J J  
 ; <? D <?  
 < KJ  
 < : J  
 / - ' Q : / ' ' @ F , , - ' )'  
 O : L + ( +  
 ? D @ O : L 1  
 ; 8 J ) O : L / 0  
 : : J ( O : L ( )  
 J : J & D : J / O : L ) \* + , - . ( ' ( \*  
 = J J J \* O : L ( - ( . ( /  
 < : J ) O : L ( 0 ) '  
 ; <? ) O : L ( ( )  
 D <? ) O : L ( + ( .

( ' Q : L

: : J

)





/\*

# '''DN ;:J

```

..... . Q; : /' ' /* K<C<G<I D SOG
. '''DN ;:J Q; : /' ' K<C<G<I D SOG J@F: F; < G@ Gif|Yljs G

```

(%

/\*'''DN ;:J

```

/*
J>S('), &(. %+$D /++ *
'''DN
) ^, ' fl
(^*' fl
/* ;:J K<C<G<I D SOG
; 8J D: J J: J =JJJ
0 8G 8G= 8G
- )
(
/* ; <?
Q; GJ+' ' ;:J
/* J9: GC
+' 'M J@F: F; <
C ,
F J@ V i

```





-----

;/+ \*\*' DN  
 ; : J ; <? D<? <?

.....  
 .....

... /+ ; : J ; <? D<? <?  
 'Q : /' \*\*' DN

(%

- 2 \*\*' DN ) 2 - ' ' DN /  
 \* ( / ' DN

/( \$ / + + 2 \*\*' DN

; : J 9X\p @ = @0'  
 ; <? 9G: 8CJK? FD D @ I F I <:  
 ; : @ 8 M "

/, /- ) 2 \*\*' DN

; : J ; <? < K J 9G: <? D <?  
 O; G J \$ + ' ' "

) ' ' + ( '  
 /, // ) 2 - ' ' DN

; : J

J.

/ ; : J

/, /- / O; G J \$ + ' ' "

/ ; : J

/( \$ / + ( 00, \$ ( 000

) ' ', / ( \$ \* ; : J

; : J

) ' ( ( \* /+  
 +

) % C J K ? F D

/+ 8 C J K ? F D ' \* \* ' D N

; <? 9G: ; : J

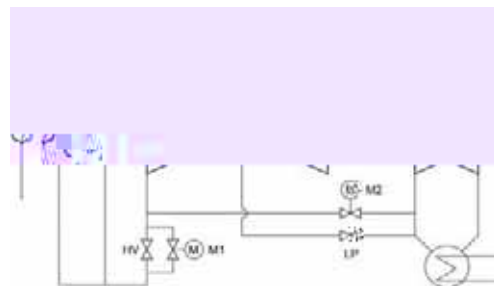

(

) % '  
 ) % % '

/+ \*\*' DN ; : J ; <? D<? <?

)%%`

)%%`

\* )' (
\*, 0
,' + ' /'
)%%`

)%`

)%%`

D (
? G CG

)%%`

D (
(%D GX

)%%`

@M (''i&d`e
>M (''i&d`e
(O' D ( D)

)%%`

(')i&d`e
\*''i&d`e

)%%`

CG (%D GX
@M

)%%`

?G

)%%`

?M

)%%`

@M CG

)%%`

)%%`

)%`

(S+ (O'

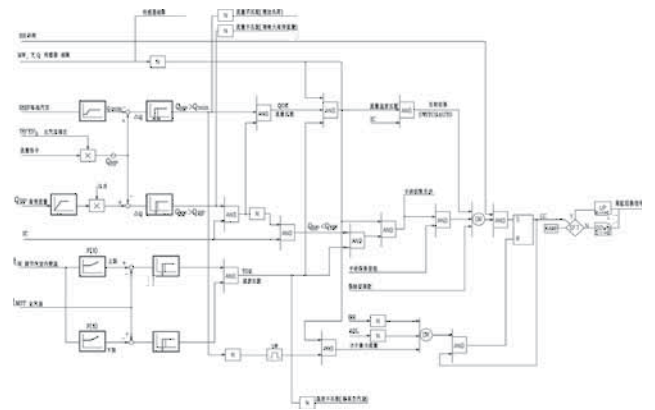

):<?

È

)

/+

\*\*'DN

::J

:<?

D<?

<?



# /( ( \* ' ' DN ; : J ; <? D <? .

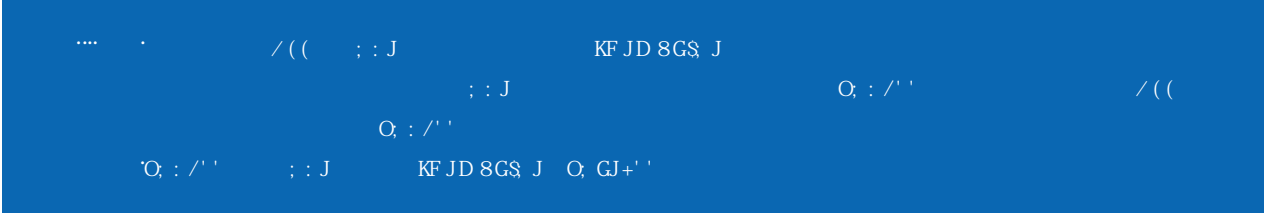

(%

/( ( ; : J  
KFJD 8GS, J ; 8J D: J J: J  
=JJJ D <? <: J

)%

; : J  
(ž  
)ž : J

\*ž <? <KJ O; GJ+'' ; : J

+ž

, ž J@

-ž

\*%

/( ( ),  
; 8J D: J J: J =JJJ D <? ; <? <KJ <: J  
; : J

\*%

O; : /''

/( ( \* ' ' DN ; : J ; <? D <?

/(( \*' DN :: J : <? D<?

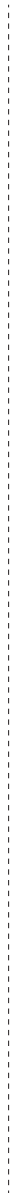
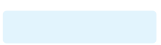

/\* /+

)!\*)' DN

... /\* /+ )' ( , O; : /''

; 8J D: J =JJJ J: J <: J 9GJ ; <? D<? <KJ

'O; : /'' \*)' DN N 'KSOG

(%

:: J

+ \*)' DN +

:: J

KSOG J, 'GC

/( /)

FMBK@E /\* /+'N

O; : /''

)%'

/\* /+ :: J

J: J ; 8J =JJJ ; <? D<? 9GJ

GC

:: J

:: J

:: J

; <? D<? <KJ 9GJ <: J 9K>

\*%

:: J ; :: J

\*%'

:: J

9K> <: J

)%

(ž :: J ; <? D<? 9GJ

)%'

)ž :: J ; <? D<? 9GJ

KSOG

\*ž

; <? D<? <KJ 9GJ <: J

+ž ; <? D<? 9GJ <KJ ; :: J

9K>

O; : /''

GC: GC: ; :: J

, ž9K>

/\* /+ )i\*)' DN





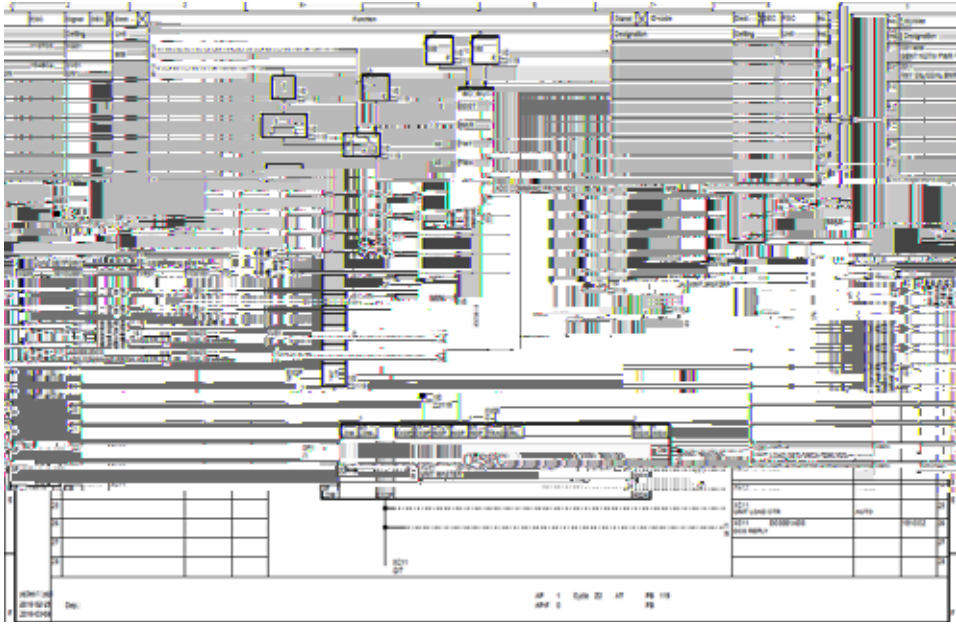

ND (\*i) DN  
+ / \*  
/ +

))' MB:  
))' MB:

..\*

GC



" k

: ( \*..DN ; <?



(ž <? SM  
@F

O; : /' ' 9  
O: L  
@F

O: :

)ž

: GL

, ž O; : E <K) %

\*ž

/d j

- ž? D @

žJMž  
oJM

žJ; ž  
CM K

žCGž

+ž

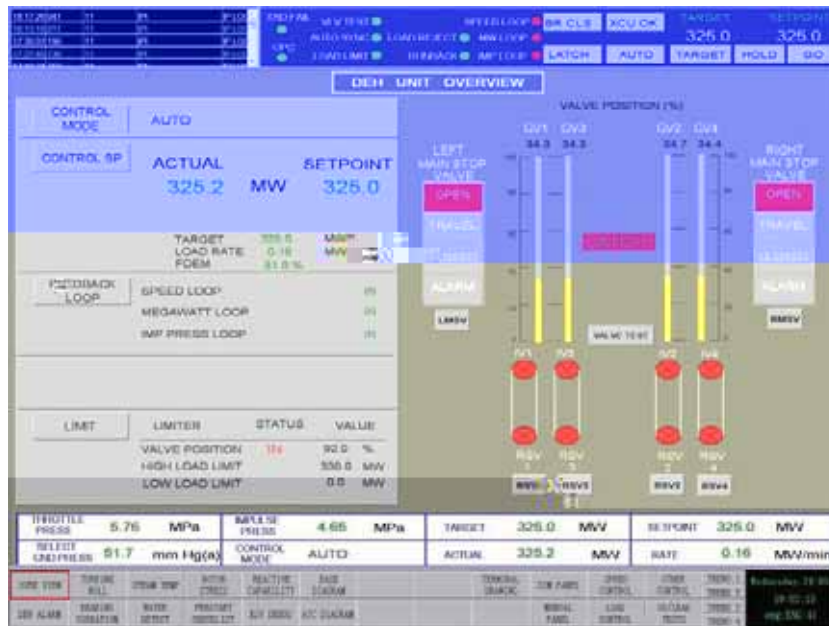

\*; <? SM

+%

)u\*

:(

:( S +

\*, ' ' DN u+ ' ' DN

/fl

: ( \* ' ' DN ; <?

: ( \* , D N ; < ?

/, /- ) i\*)' DN ;: J ; <?

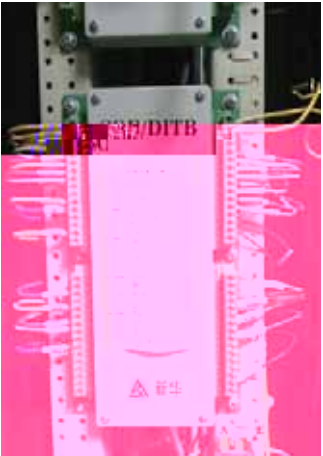

(

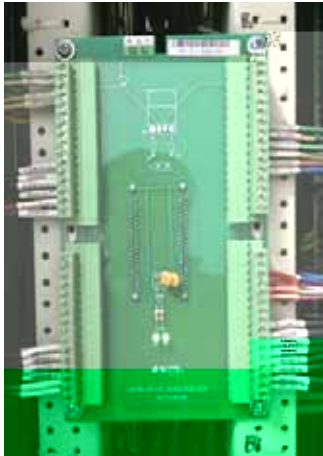

)



\*

"

;;J

; <? D<?

( J@ (

(  
Q: /'

#5机组电

+



)% ..

::J

)%`

::J

::J

::J

)%`

::J

::J

::J

::J

)%`

::J

O: L

O: L

@F

8@

8F

/, / - ) i\*)' DN :: J ; < ?



/, /- )!\*)'DN :: J :<?

; F

; @

)%`

:: J

:: J

)%`

:: J

:: J

\*%

/, )'(- () )'(. \*  
-') ,) /-  
)'(. + )'(. - ..

+/

:: J

/, /- :: J

:: J

:: J

:: J

:: J

(ž :: J

)ž :: J

(%d d C<;

\*ž <? &D<?

+ž :: J

,ž GC :: J

-ž

.ž <: J :: J

/ž

Ož : J

('ž :: J :: J

O; : /' '

O; GJ+' '



;/+ \*''DN  
;:J

```
... /+ )'() 0 O: :/' ' N; G=S  
J9: <: J 9G: ;<? S O: :/' '  
O: :/' ' ;<? S *''DN ;:J
```

/+ \*''DN ;:J

( /+ O: /''

)%`

::J

J8D8

::J

@&F

::J

::J

::J

)%`

::J

+

::J

+

::J

/+ ::J

)%`

::J

::J

@&F

O: L

O: L

8@

8F

/( \*''DN





Ž' ' DNŽ  
/,  
; : J ; <?

; GL )(
 (ž
 ; <? ; GL' (& ( ; GL') &)
 KD: J ; GL(+&+
 KJ: J ; GL(, &, ; GL(- &- ; GL(. &.
 ; GL(/&/ ; GL(O&O
 )ž
 =JJJ ; GL' \* &\* ; GL' +&+ ; GL', &,
 9J: J ; GL' - &- ; GL'. &. ; GL' /&/
 9D: J ; GL' O&O ; GL(' &' ; GL(( &(
 <: J ; GL() &) ; GL(\*&\*
 \*ž
 8: : ; GL. (&( ; GL.) &)
 O: L
 O: GJS+' ' ; GL O: GJS+' ' ; GL
 )
 O: L )+M
 O: L O: L O: L
 O: L
 ; GL. ) &) O: L- +&+ O: L- , &,
 O: L & \k ? L 9 9: & \k
 @F @F
 O: L & \k



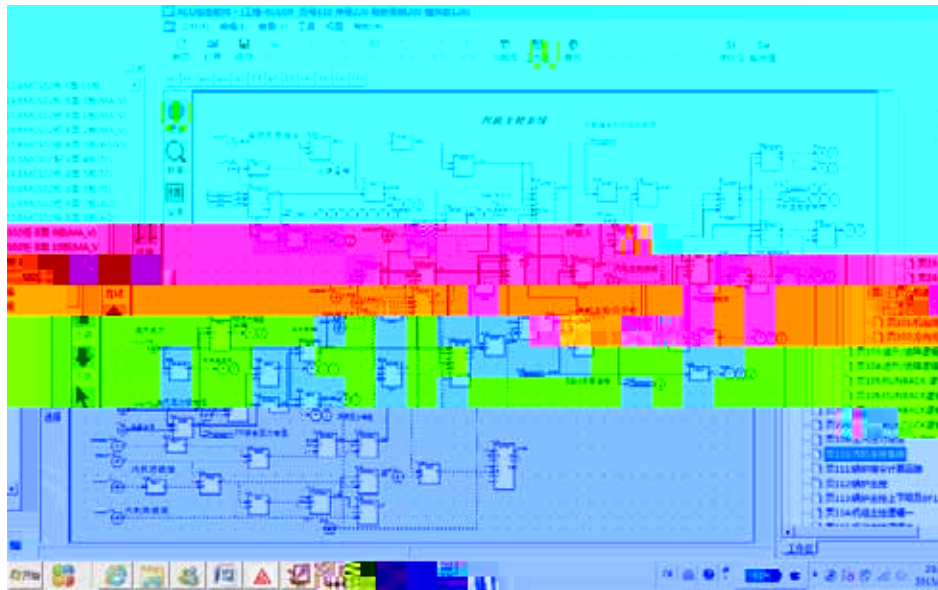

+

O: GJS+''

O: L

O: GJS+''

; : J Q : / ' ' ; <? &D <? Q GJ+ ' '

```
... . /+ )' ( ) 0 Q: : / ' '
N; G=S ; : J ; <? &D <?
'Q: : / ' ' Q: GJ+ ' ' * ' ' DN ; : J & <? &D <?
```

( %

( O / )  
) ++ ' DN  
/ \* + \* ' ' DN  
( O O / ( O O ; : J  
N; G=S ; <?  
; <? S  
; : J  
) ' ' O / \*  
Q: : / ' ' N; G=S ; : J  
= J J J D: J J: J <: J ; 8 J J 9:  
Q: : / ' '  
+ ; : J  
/ \* ; : J  
; <? &D <?  
; <? &D <?  
) ' ( ) / +  
; : J ; <? &D <?

) %

/ + ; <? &D <?  
Q: GJ+ ' ' ( ' ; <? &D <?  
; : J

\* %

; : J  
; <? &D <? ; : J  
; : J  
; <? &D <?  
\* %  
Q: : / ' ' Q: GJ+ ' '  
6 J  
&A -



Q: /''

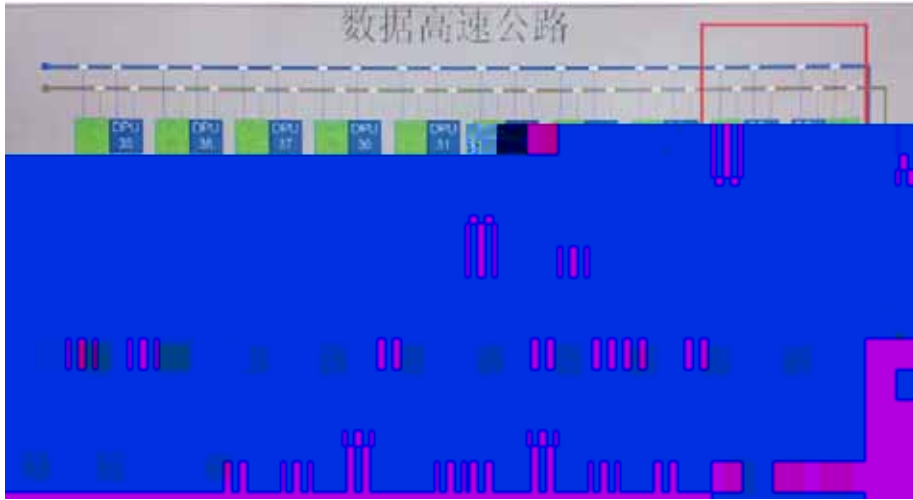

)'

\*%

\*%'

O; : / ' ' ; : J

O; GJ E<KN @

gf`ek[ `iZ]^ 80 ; O ; : J

E<KN @

\*%`O L

O: L

O: L: =>%O< O; GJ O: L O: L  
 ( O: L: =>%O< ( =l e[\]  
 ( 9: >: 9+- +%cc O: L: =>%O<  
 =l e[\] O; GJ  
 ; SO; GJ- %SY`eSD D@ =l e[\] O: L  
 9: >: 9+- +%cc  
 : EN @; FN JSj pj k d \*) O: L: =>%O<  
 E<KN @ O: L: =>%O<  
 ; : L: =>%O< )  
 \*  
 O; GJ

O: : / ' ' ; : J

\*



\*' ; GL: => O: L: =>

+%

+%

0

+

G@

\*

+ p

o

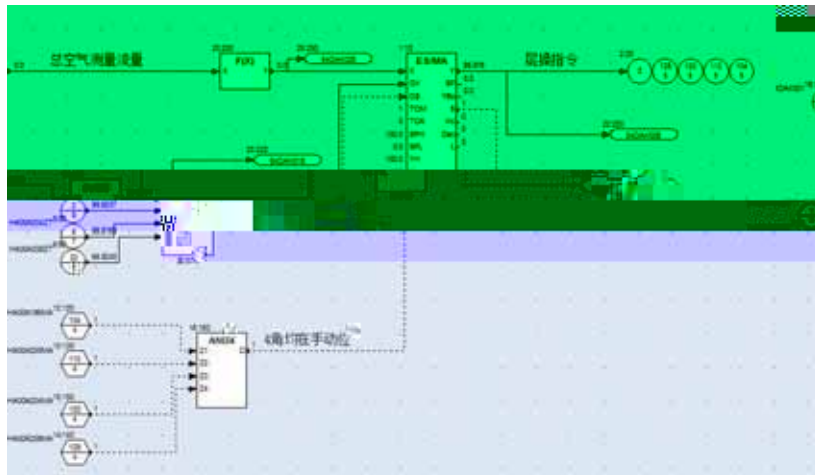
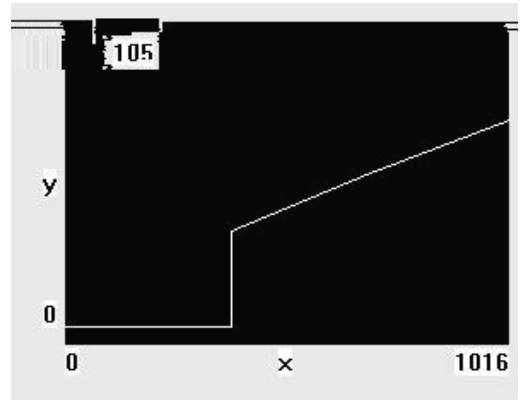

+%

+

O: L

)

>=K

=JJJ

)

>=K

F=K

=JJJ

.+ O: L

.+ O: L

; GL

; GL O: L

O: L

; GL

| 功能块属性 NDO                |           |
|--------------------------|-----------|
| 参数                       | 输入   属性   |
| GD (开关量点名称)              | 740XSW014 |
| SH (是否被其他XCU共享, 报警复归时是否) | 共享, 自动清除  |
| T (上电周期)                 | 块内计算周期上网  |
| AA (报警定心)                | 无报警       |
| P (报警优先级)                | 0         |
| T1 (延迟重复报警时间秒)           | 0         |

- O: L

./ : ' O

\*



/-

)''DN ;:J

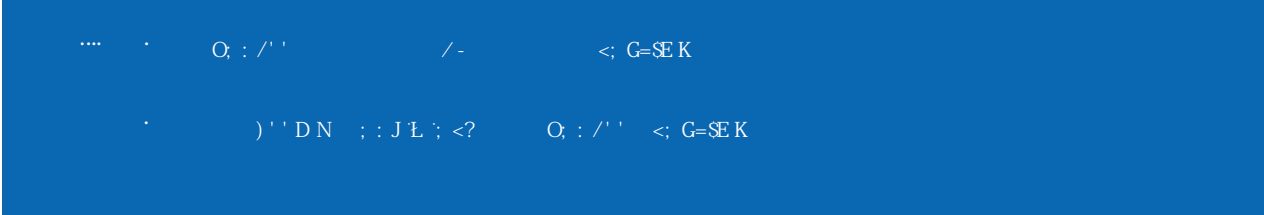

(%

O; :/'

N > Q- . ' & (+ ' S

<; G=SE K

EB) '' S() %& \*, & \*,

)%'

;:J ; <? )'' /

<; G=SE K

EK, %

;:J

(O ; GL

) @&F ; 8J

)%'

( @&F

; 8J

) @&F

+S)' d 8

)%

)%'

<; G=SE K

; <?

;:J

;:J

/- )''DN ;:J



```

*%
/- ;:J ;<? <KJ
<; G=SE K
D =K ? D @
;:J
*% ;:J
;:J @F @F O; :/'
D =K
(ž ( ( ( D =K
( ;:J
)ž ) @F ; F (
*ž ( @F
+ž ( ;<?
,ž (
*% ? D @
8&9
; <?

```

/- )' DN ;:J

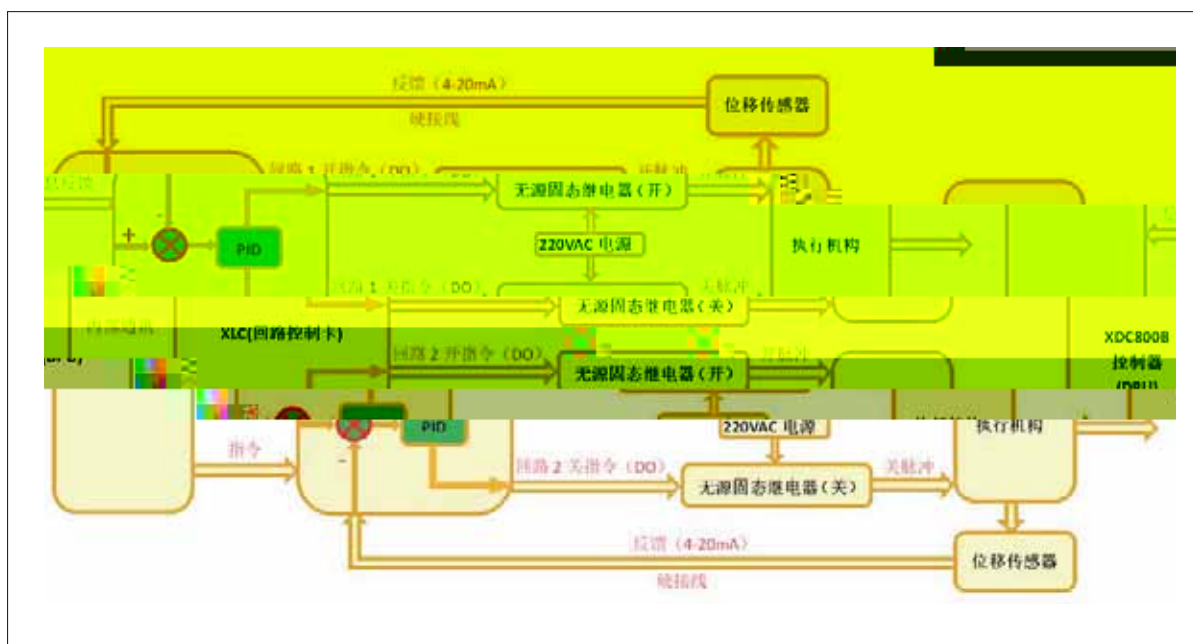



- ' ' DN ; <?



(% ; <?

\* +  
E - ' ' S) +% & - - & - -

; : J ; <?  
=F O9F I F @8  
=9D J M?

- ' ' DN ; <?

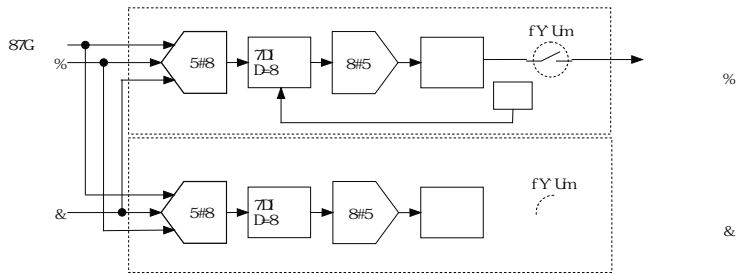

\*%%'  
 (ž s ŽžS: ŽYžs3 (' fl ' fl 3:  
 Žž : ŽYžs (' fl #  
 )ž s ŽžS: ŽYžs5 (' fl : 4D @ Ž  
 Žž : ŽYžž :  
 \*ž ( , fl ' %M  
 +ž ) (' fl ' %M  
 , ž +u) ' D 8 ) D

ú

D

!

Ê

~

Ì

(2



+





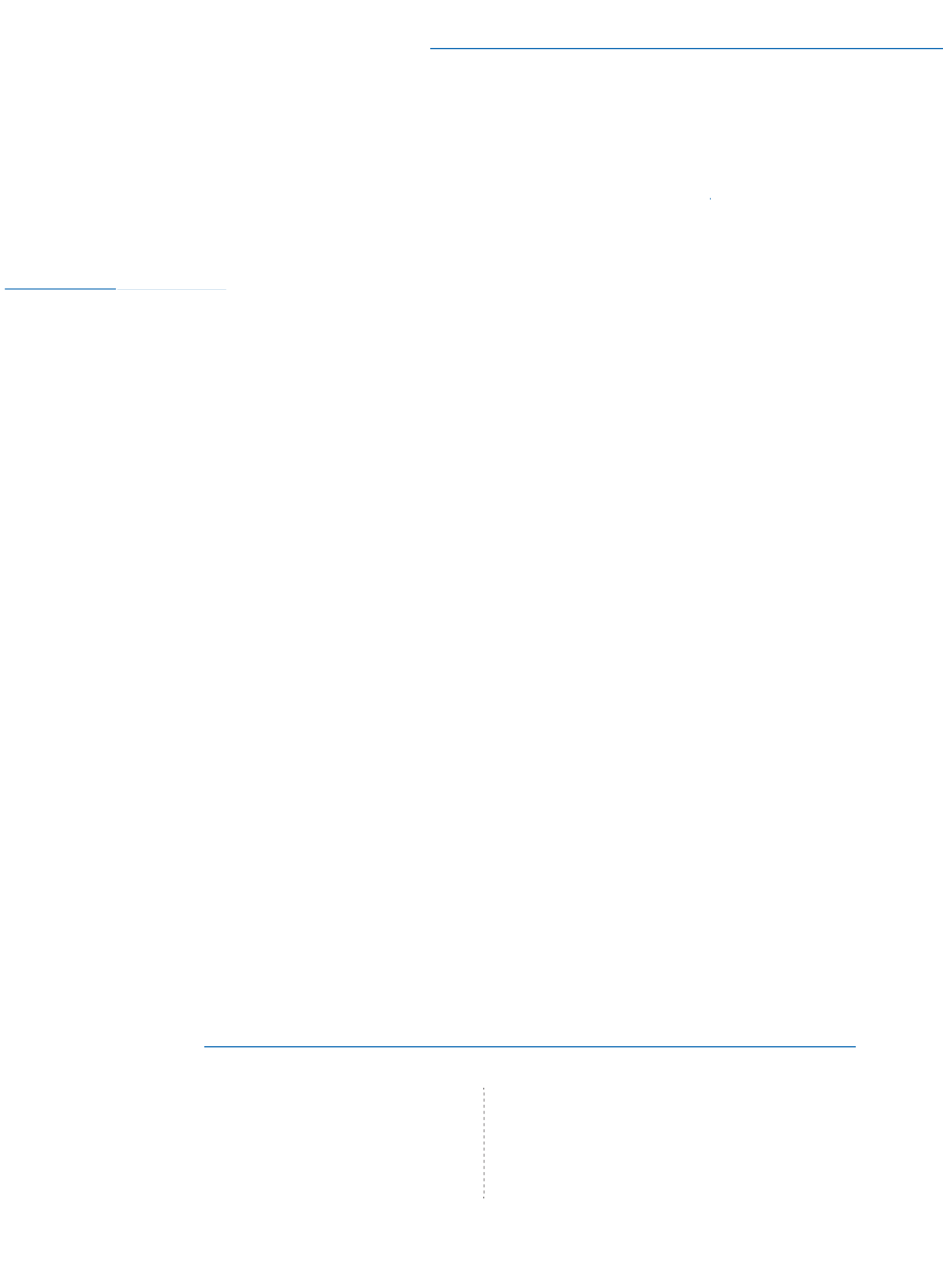

⋮

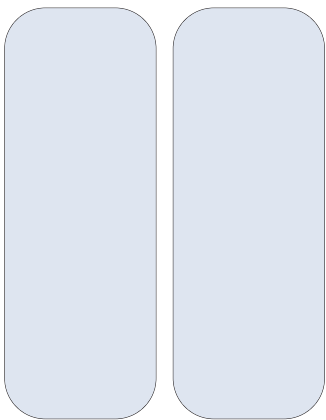

€ÿázOòœ y μÁÁg >\*) "z7•æ  
-μZo•...`fG∈CNμàízë «'WûÖÒk÷^  
g W•OÝo•j†âägÄ Whk →M•²jσ•uÊû  
xož  
-p-2%) -0{.« w tðO ~À•°W•p»ð•€` `tàKP àT0q`j`ùĐ`  
xož †

•  
û  
,

Ô  
G

4  
ü  
à

•  
Ñ  
%²  
O

£ |yÿ9

Nμ>\*)

%²  
}

w  
-

†

8>:

.... . 8>: 8>: /+  
::J 8>: ::J 8>:  
. 8>:

/+ \*' 'DN  
KGI )' ( ;:J  
Q; /' '  
8>:  
(%  
\$  
(%` 8>:  
(%`  
(%`  
(%`  
)%`  
....

)%`  
(ž  
)ž  
)%`  
; <?  
; <?  
)  
(ž  
)ž ; <?

8>:

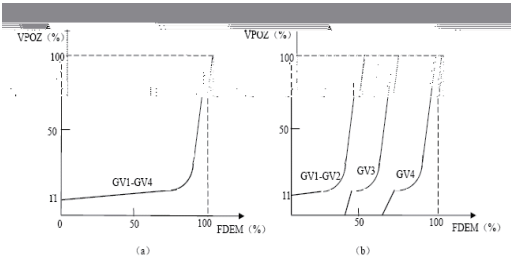

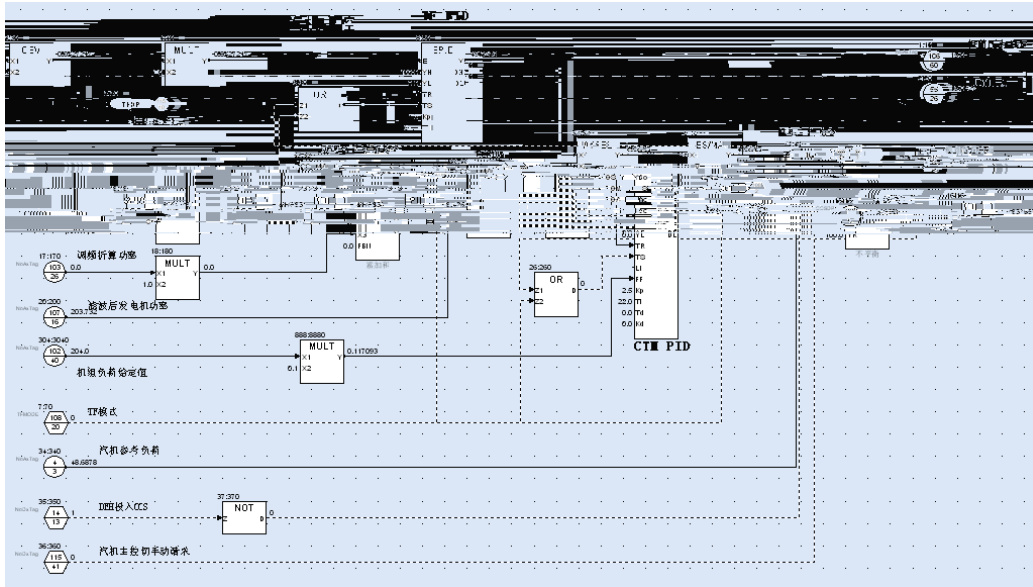

\*

+%

8>:

/+ \* ), ;:J . )(

<?

\*fl \$ fl

8>:

8>:

)' DN

\*

(' DN

+%

\*fl \$ fl

∞

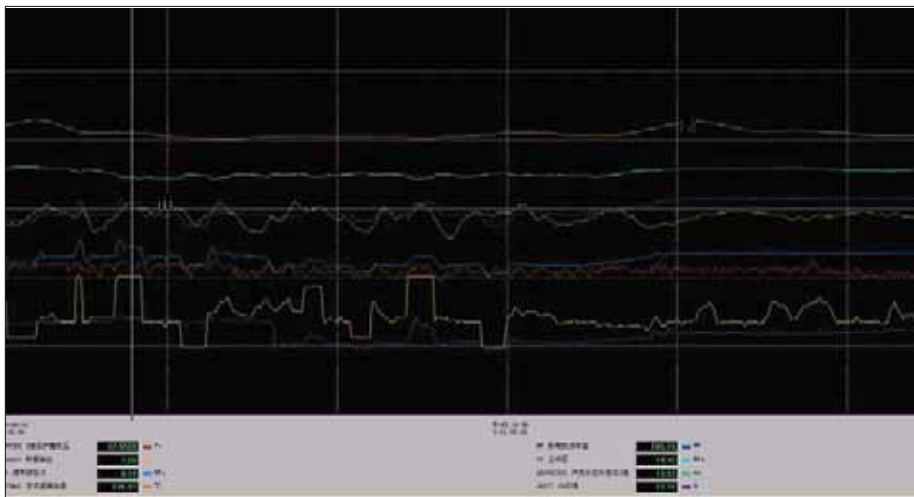

+

+



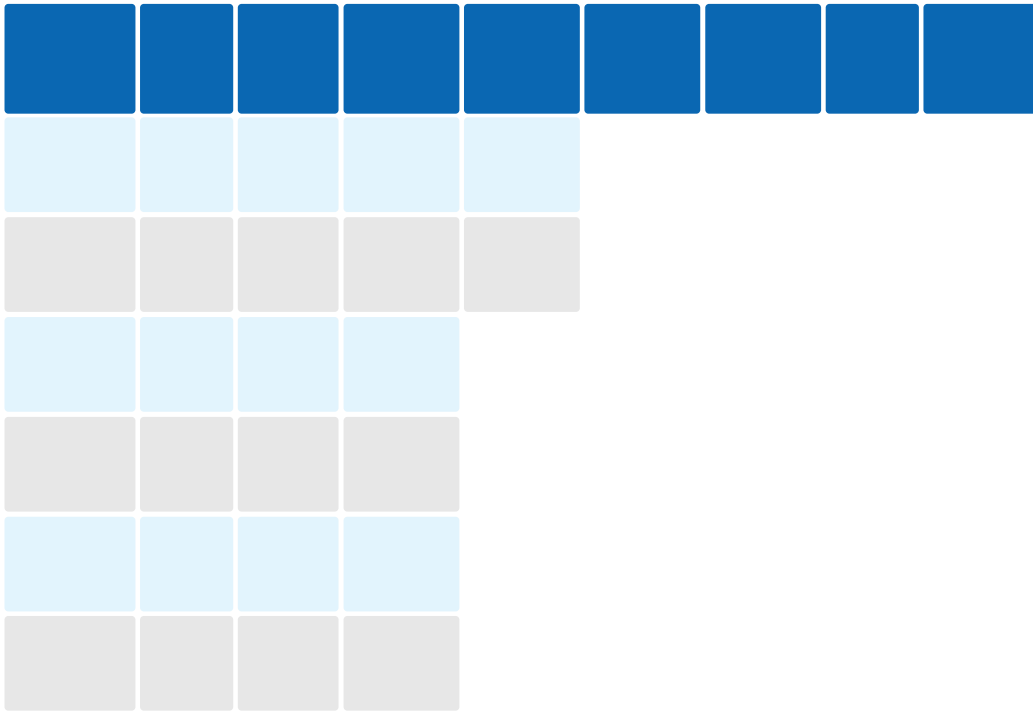

(7+ 8>:

8>:



8>:

# \*''DN

... /- \*''DN ;:J

O; /''

O; /''

\*''DN

+<sup>2</sup>\*''DN /- ()''DN  
; >S('), &(/%S@@

E\*''S(-. &\* . &\* .

;:J

D:J ; 8J J:J  
: <E KLD SOC =JJJ @E=@O'  
; <? D<? ; <? \$@@@ <KJ

O; /''

8>:

(%

D 8E

K=

9= ::J

8>:

LC;

(%'

(Z@=

BR G( &GK <sup>2</sup> GJGT

G(

GK

GJG

G( &GK <sup>2</sup> GJG

GJG

)ž : J

BØ N JGT

D N JG

::J

' %D GX

\*ž

' S('' fl

' S(-/k

(%'





)%'

)%19

I 9 I 9

I 9

I 9

I 9

)

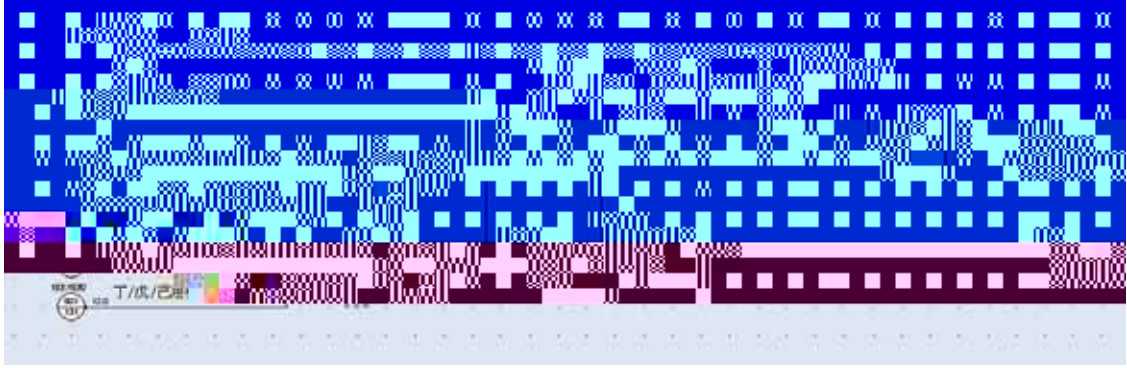

) 19

\*%

' %D GX

(%D N

' %+D GX

(%D N

\*

)' 'DN

\*' 'DN

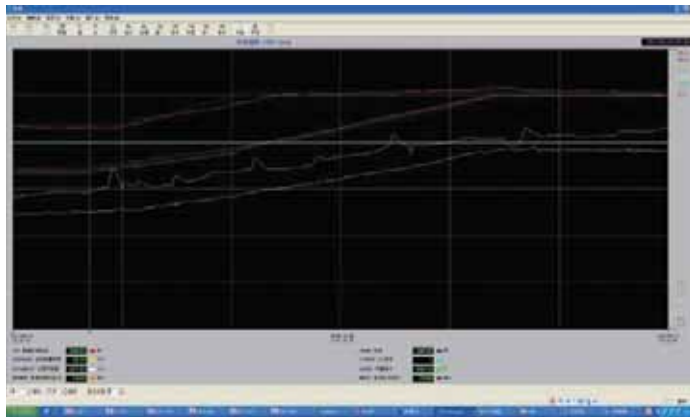

\*' ('DN

+%

; : J

O; : /' '







IleYXZb

D: J =JJJ D: J

: ;

8 9

: ;

8 9

IleYXZb ODN &d`e

G@

\*%`

98Q

8&@

D=K

D=K

. , fl )'j

IleYXZb

IleYXZb

IleYXZb

IleYXZb

IleYXZb

G@

IleYXZb -' fl

-' fl IleYXZb 8 ' fl

9 O' fl

G@

-' fl

G@

+, fl

G@

O: /'

\*

D: J

\*IleYXZb



; <?

.....

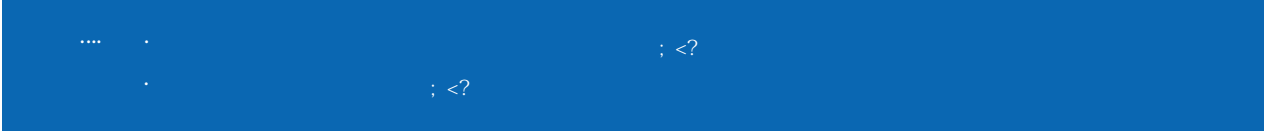

∩ ∪

; <0 A

c

⊆[

D



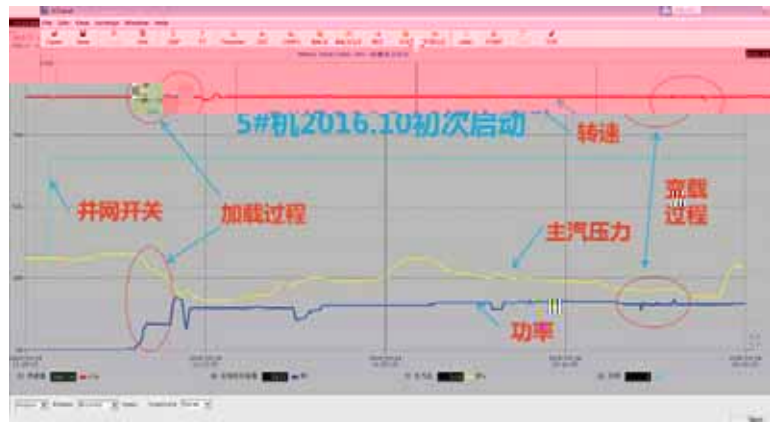

)  
 ; <?  
 )' ( .

:(  
 N; G=S@@  
 Q: /' ' ; <?

- : (

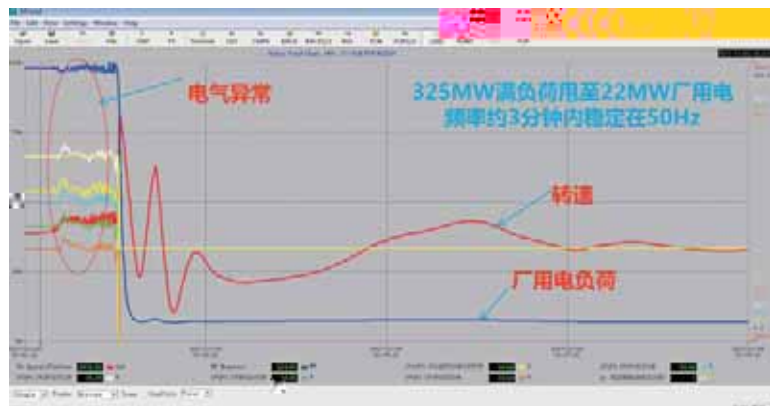

- : (

\*

/(

/(



/( =: 9





...

EFo

J: I EFo

...

G@ Ž f [\c& i'me' knf S ^i\SF]S=i\\[fd'

G@ D; SK; F=SG@ ž G@

D; SK; F=SG@

G@

\*' 'DN

- ' 'DN \*

D; SK; F=SG@

G@

EFo

\*' 'DN G: 8

C\meY\i^SD Xi hl Xi[ k 9G

\$

\*' 'DN

(%

EF)

(%''

+

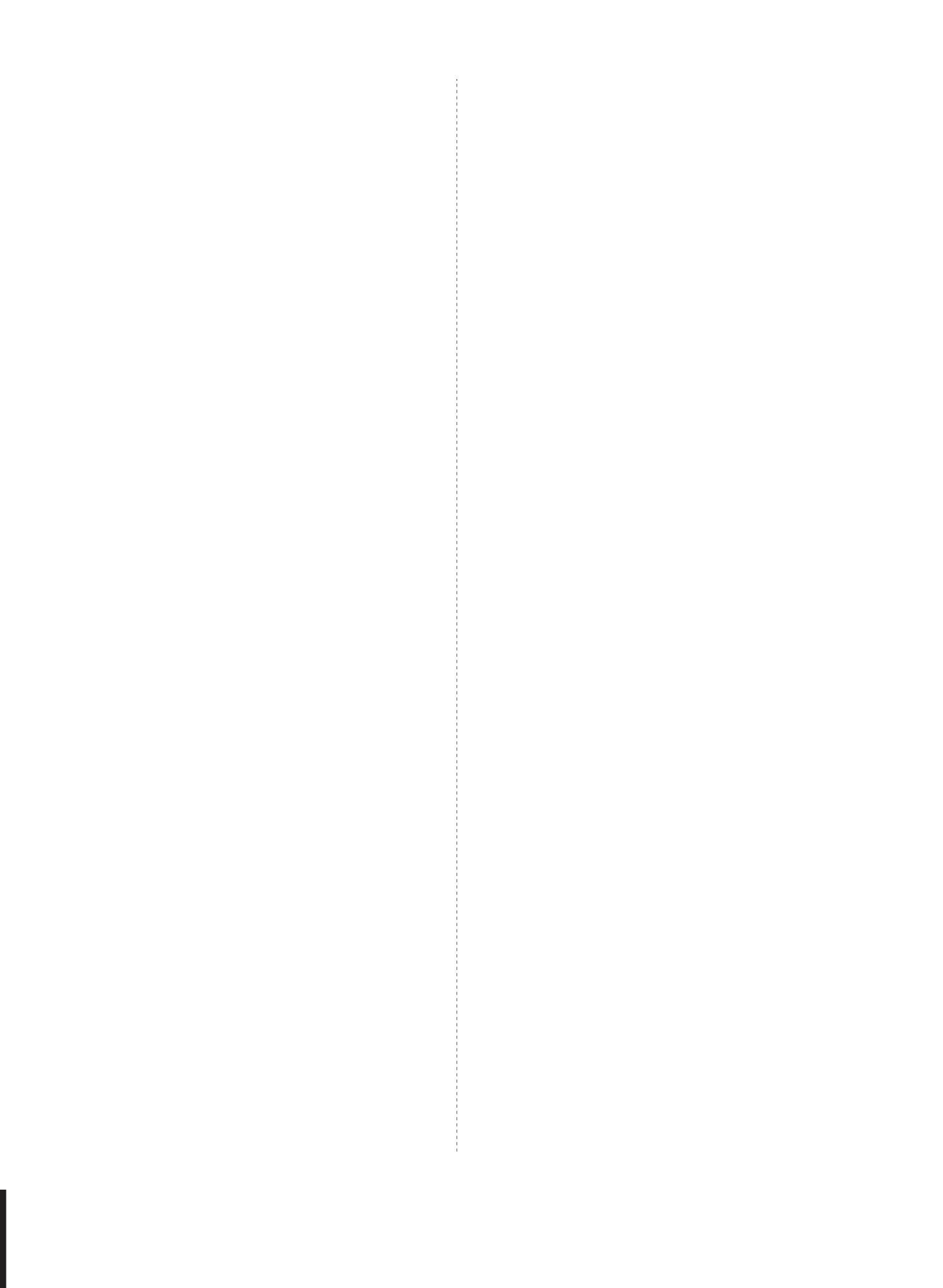





8/1

8/1

8/1

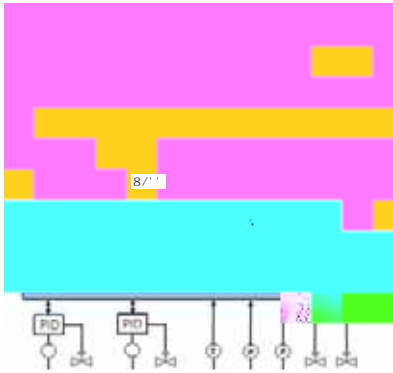

8/1

8/1

8/1

D f [ 9 ] j & F G :

( &

) ž

G@

D G : "



8/1

\*ž

:: J

8 > : Š

8 > :

Ž & B G @ ž G @

Ž & B G @ ž G @

J : I

E F o

: = 9

: = 9



/ ; : J

: : J

Ž K < 8 D C E ž

Ž P 8 8 : : ž

Ž F @ < I C E ž

Ž K D K ž

Ž ? < J < K ž

Ž < ? K J K K ž

Ž L I I ? K J K K ž

Ž < ? K = C S

9 8 C ž E F o

Ž F O ž J : I

E F o

Ž E F O G I < ž

Ž 9 8 C 8 E : < ž

+ž

0

Δ e

== (

M B G @

G

@



0

==

|  | Ž Ħ G \&d `ež |  | )    | )% )% |  |
|--|---------------|--|------|-------|--|
|  | Ž Ħ G \&d `ež |  | (%   | )     |  |
|  | Ž ž           |  | -'   | *'    |  |
|  | Ž Ħ G ž       |  | ..(% |       |  |
|  | Ž Ħ G' ž      |  | ..)  |       |  |
|  | Ž ž           |  | ...* | ...(% |  |
|  | Ž ž           |  | ...+ |       |  |

/( ' \*\*' DN  
 N > Q( ' ' & . % , S  
 : \*\*' &\*) ' S(- %

. & \* / & \* /

H=JE S \*\*' S) S) ' +

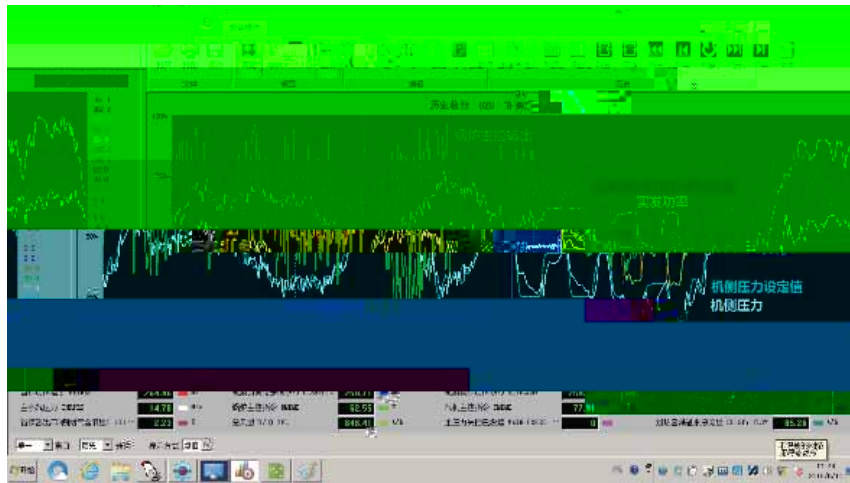

( ' : : J

J: I E F o

(( )

J: I E F o

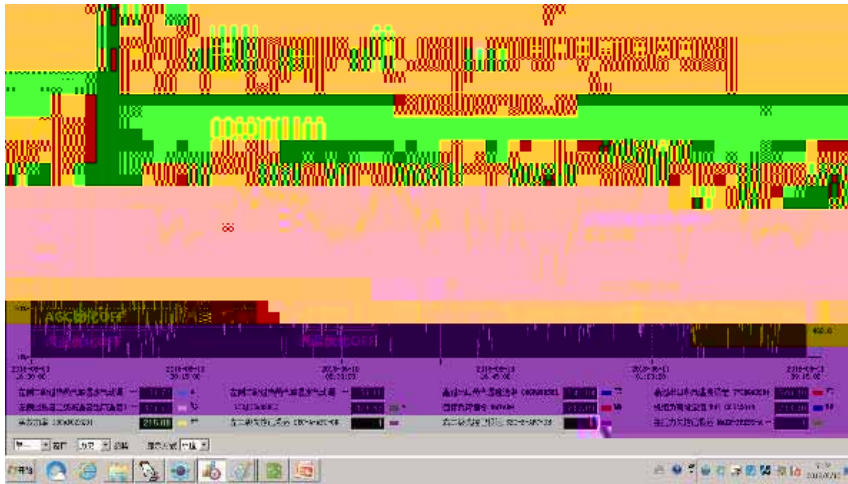

((

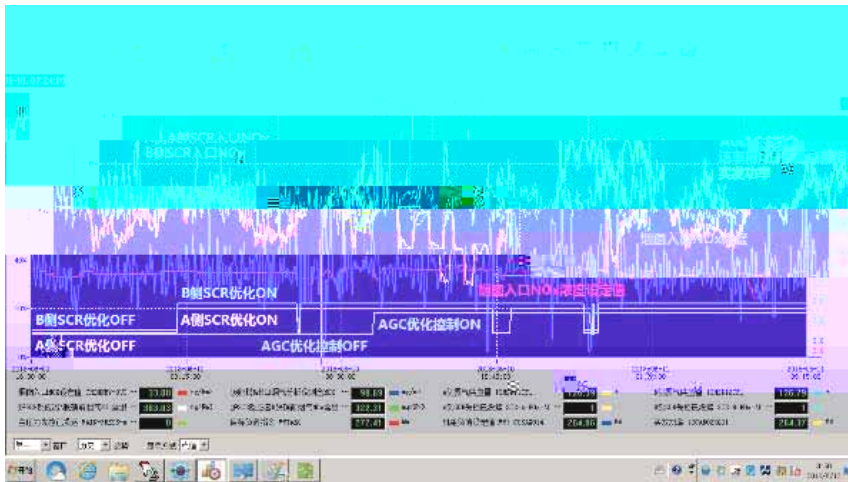

()

E F o

\*%

8>: J: I E F o

8>:

žBG@ ž

)' (/

G@

8>: Œ

8>:

/( /) )!\*, ' DN

|           |           |           |
|-----------|-----------|-----------|
| )!*, ' DN | GI F =@LJ | Q : /'    |
| Q : /'    | *, ' DN   | GI F =@LJ |

/( /) )!\*, ' DN



/( / ) i\* , DN

.....

+ž ; G



/ ; G

, ž



0

\*%`

(ž JP: FE%k e\k \mZ\ Zfe]^\iXkfe

)ž &

Df[l c\j

& @j\ik



(' &

\*%`

JP: FE%k e\k \mZ\ ; fnefX

:: S G



((

\*%` O: L

\*%` cY: ; g: imf

\*%` : ; ge%`

:: ; ge%` ; G G I F = @LJ

O: L

O: L : : S G

:: S G

O: L

:: ; g(%e` : ; g)%e`

:: ; g\*%e` ( : ; G

:: ; ge%e`

Rfe]^T

JKkfeEld4(' ; G

JKkfeEf4(' : ; G

GfikEf4\* : ; G

GkEf4(' : ; G

BKkfe(T ; G

JKkfeEf4(( ; G

GkEld4(' ; G

BKkfe(\Gk(T ; G

; Eld4'' ; @

; fEld4'' ; F

8Eld4)'' 8@

8fEld4)'' 8F

GfikEf4\* ; G

GkEf4)'' ; G

\*%` nOZl %e`

Rf ; I @k-I T : ; G

DRIVERn=libCCDpDrv.so,5,8,16

\*%`

@F

\*%`



()



>1 X[

>1 X[

1



+

+ ..

+ % :

> 1 X[

> 1 X[

+ % % :

> 1 X[

> 1 X[

9& " : &

9&

D pJHC N \Y

Kf d ZXk

N \Y

+ % % :

> 1 X[

N ] :

«

A

Xk

HC

° :



0`>1 X[

)ž

LJ9



(`>1 X[

+%%`

>1 X[



/`>1 X[

\*ž



((`>1 X[

+%`

+%%`

+%%`

+%%`



0`>1 X[

+ž

, %

>1 X[

:(

>1 X[





